

Pauluhn Summit LED luminaires

Cl. I, Div. 2, Groups A, B, C, D
Cl. II, Div. 1, Groups F, G

UL Listed
CSA Certified
Type 4X; IP66

2L

2L

Pauluhn™ Summit linear LED luminaires are designed to replace fluorescent T12, T8 and T5HO luminaires in hazardous rated hose down, food processing and corrosive environments. Three models of the Summit are available, from 13,000 to 25,000 lumens.

Model	Typical lumens (Type V) ^A	Watts	Lumens per watt	Equivalent fluorescent luminaire ^A
SUM13L	13,000	122	106	3-lamp T5HO
SUM17L	17,000	144	118	4-lamp T5HO
SUM25L	25,000	217	115	6-lamp T5HO

Applications:

- Harsh and hazardous areas
- Food and beverage processing facilities
- Pharmaceutical processing facilities
- High pressure wash down and corrosive environments
- Agriculture storage and processing
- Power generation

Features:

- High efficacy – 100+ LPW
- Angled light fixture for debris shedding
- Surface mount, cable mount and threaded rod mount
- Replaces up to 4 foot 6-lamp T5HO
- Operating temperature: -40°C to +55°C^B
- 1,500 PSI hose down tested
- Minimum 60,000 hour LED and driver life at 40°C ambient
- Through feed design for multiple fixture wiring
- 5000K, 80 CRI
- 5 year fixture warranty

Certifications and compliances:

- Class I, Division 2, Groups A, B, C, D
- Class II, Division 1, Groups F, G
- CSA 22.2 No. 137
- Type 4X, IP66
- UL standards: UL1598, UL8750, UL844
- NSF Splash Zone

Standard materials:

- Housing – Type 6061 aluminum
- Lens – polycarbonate; diffused polycarbonate (optional)

Standard finish:

- Paint – epoxy powder coat

Mounting options (ordered separately):

- Surface/swivel mount
- Cable/chain mount

^AAll T5HO lamps used in comparison are 4 ft. length.

^BSUM25L model is 50°C maximum ambient operating temperature.

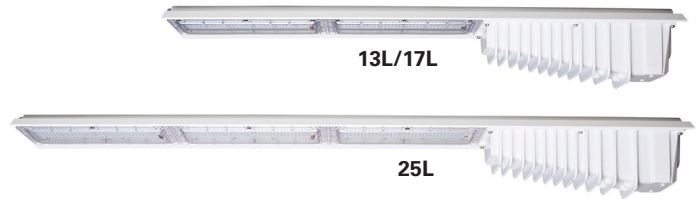

Electrical ratings:

	SUM13L	SUM17L	SUM25L
Voltage range, VAC	120-277 VAC; 347-480 VAC		
Frequency	50/60 Hz		
Input power (watts)	122	144	217
Input amps at 120-277 VAC	0.26 - 1.03	0.31 - 1.20	0.46 - 1.78
Voltage range, VDC	127-250 VDC (UNV1 model only)		
Power factor	>0.90		
Total harmonic distortion (THD)	<20%		
Nominal lumens	13,790	16,680	24,679

Drivers:

Option	SUM13L-SUM25L
/UNV1	120-277 VAC, 50/60 Hz; 127-250 VDC, 50/60 Hz
/UNV34	347-480 VAC, 50/60 Hz

Temperature performance data:

Model	40°C	55°C
Class I, Division 2	T4A	T4A
Class II, Division 1	T6	T6

Weights:

Model	Lbs.	Kg.
SUM13L	23.41	10.61
SUM17L	23.41	10.61
SUM25L	31.28	14.19

Photometrics:

- Refer to www.eaton.com (under the Resources tab of each product family) for specific photometric IES files

Pauluhn Summit LED luminaires

Cl. I, Div. 2, Groups A, B, C, D
Cl. II, Div. 1, Groups F, G

UL Listed
CSA Certified
Type 4X; IP66

2L

Rugged high bay solutions. Pauluhn Summit LED luminaires are engineered to provide maintenance-free performance, while delivering long life and high lumen output for applications in hazardous rated areas.

2L

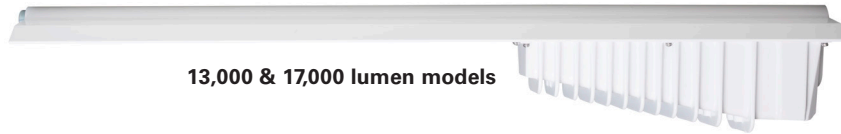

13,000 & 17,000 lumen models



Innovative design for demanding applications:

- Angled light fixture mitigates debris build-up
- Robust design withstands high pressure wash down, and food rated paint maintains safety

Improved performance and reduced costs:

- 100+ lumens per watt provides highly efficient lighting
- Rated life is up to 60,000 hours of maintenance-free and safe operation

Easily customized for application-specific performance:

- Versatile mounting options with a through feed design for simplified multiple fixture wiring
- Dimmable and occupancy sensor configurations available to reduce energy consumption



25,000 lumen model

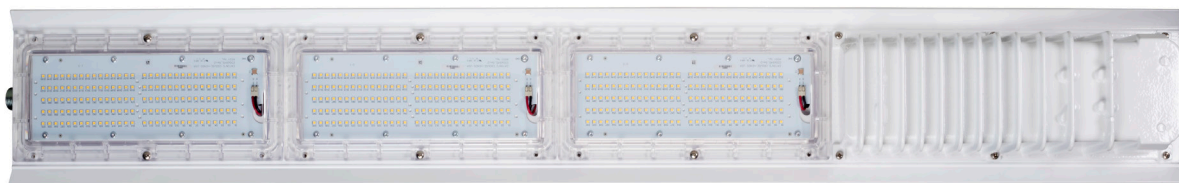

Ordering information:

Part number example
SUM13L/UNV1 S903

SUM

Series

SUM

Pauluhn Summit for hazardous rated food processing locations

13L

Lumens

13L	13,000 lumens
17L	17,000 lumens
25L	25,000 lumens

/UNV1

Voltage at 50/60 Hz

/UNV1	100-277 VAC; 127-250 VDC
/UNV34	347-480 VAC

S903

Options

S903	Polycarbonate lens
S903D	Diffused polycarbonate lens

Accessories (ordered separately):

Description

Cat.

- Jack chain/aircraft cable bracket..... **APX1093MTK**
- Adjustable ceiling mount bracket..... **APX1097MTK**

Dimensions (in inches):

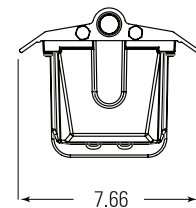
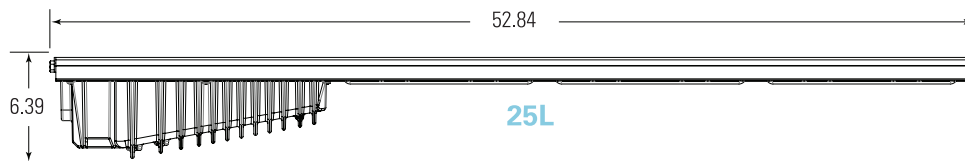

13L - 25L

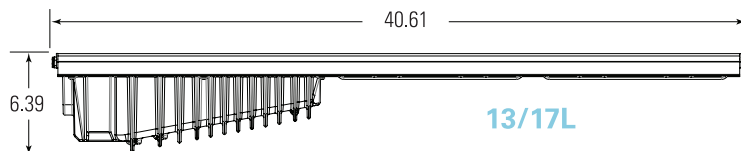

Mounting options:

Adjustable ceiling mount

APX1097MTK

Standard adjustable ceiling mounting kit includes:

- (2) 304 SS brackets and 316 SS mounting hardware

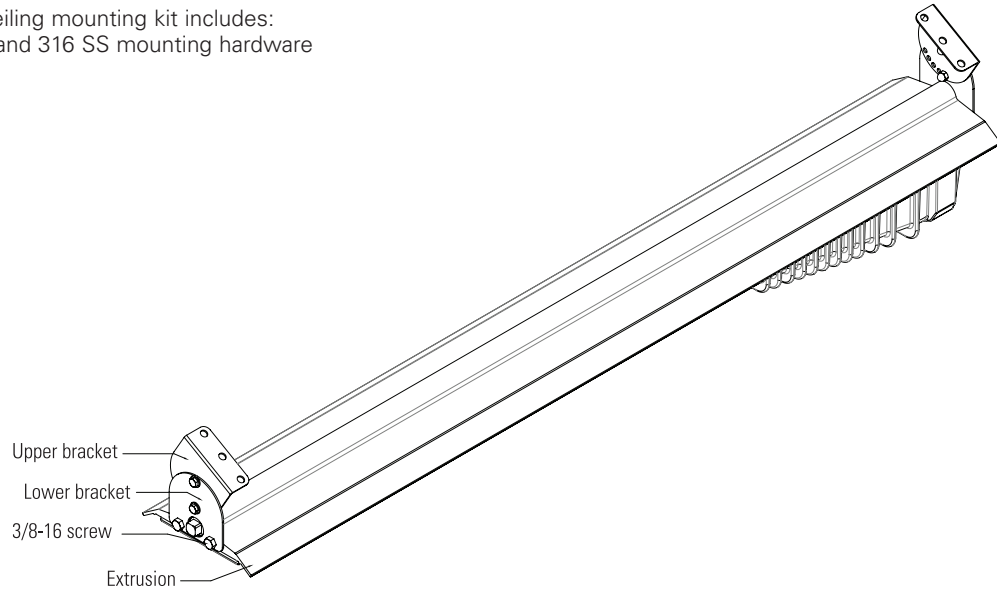

Chain mount

APX1093MTK

Standard jack chain/aircraft cable mounting kit includes:

- (2) 304 SS brackets and 316 SS mounting hardware

