

PLE Pendant LED Lighting-Harsh & Heavy Industrial Area

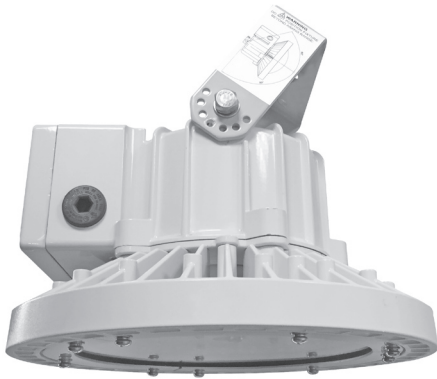

Product Introduction

The PLE product series LED luminaires using high-quality international brand LED chips, have extremely long lifespan. Multiple version of the PLE LED are available, providing ideal solutions for a wide range of applications. Perfect substitutes for 70W-175W HID Luminaire.

High intensity aluminum housing, tempered and impact resistant glass globe, heat & corrosion proof with IP66 Protection. Provide energy-efficient, safe and reliable LED lighting solution for the customers.

Product Features

• High Efficient & Energy saving

Up to 66% energy-saving comparing to HID Luminaire.

Model	Nominal Lumens	Wattage	Equivalent HID Luminaire	Energy Savings
PLE-3L	Approx.3000	Approx.30W	70W-100W	Up to 58%
PLE-5L	Approx.5000	Approx.50W	100W-150W	Up to 66%
PLE-7L	Approx.7000	Approx.70W	150W-175W	Up to 60%
PLE-8L	Approx.8000	Approx.80W	150W-175W	Up to 60%

• Industry-Best: Safety & Reliability

- Extremely low profile & light weight
- High intensity aluminum housing, tempered and impact resistant glass globe, heat & corrosion proof.
- IP66 Protection.
- 5 year lifespan
- Cold white CCT 5700K & Warm white 3000K are available
- Coating color optional

• Perfect Temperature and Optical Performance for Wide Application

- Permissible temp. range: -40°C~+55°C(Normal)
-40°C~+45°C(EM)

* Please contact Crouse-Hinds sales for other temp.

• Anti Shock and vibration

• Mercury-free & lead free , environment protection

• Instant ON/OFF

• Standard Product provides pendant mount, optional U shape yoke mount provide the greatest mounting flexibility: wall mounting ,ceiling mounting , pole mounting and etc.

• Fixture Life and Years of Maintenance-free Operation

Ambient Temperature	No. of Years at 24 Hours Usage	No. of Years at 12 Hours Usage
25°C	11	23
35°C	10	21
40°C	7.5	15
45°C	6	11
50°C	5	9
55°C	3.5	7

Application Area-Ordinary non-Hazardous locations

- Heavy industrial, mine site processing areas, platforms, loading docks, tunnels, indoor/outdoor spotlighting, outdoor wall, and areas requiring frequent on-and-off of lights
- Where extremely corrosive, wet, dusty, hot and/or cold conditions exist

PLE Pendant LED Lighting-Harsh & Heavy Industrial Area

Technical Information

Power consumption	30W-80W
Rated Voltage	AC 100V-240V 50Hz/60Hz; DC 108-250V
Power factor	≥0.9
CCT	5700K/3000K
CRI	> 70
Degree of protection	IP66
Insulation Class	I
Permissible ambient temperature	-40°C~+55°C (Normal); -40°C~+45°C (EM)
Net weight	<5kg, <6.5kg (EM)
Certificate	CE
Emergency flumen output	EM1=1.5H, 30% output; EM2= 3H, 15% output

Ordering Logic

PLE	-3L	-W	-1M	-S886	-T1	-F	-1P	-B1	EM1
Series No.	Total Lm	Color Temperature	Entry size	Entry Qty.	Terminal	Glass	Entry Acc.	Mounting type*	Emergency Duration
PLE	-3L=3000 -5L=5000 -7L=7000 -8L=8000	Default=5700K -W=3000K	-1M=M20 -2M=M25	Defult=1 entry -S886=Two entries	Default=without terminal T1=PA12(3 Ppole) T2=PA12(6 pole)	Default=Clear Glass -F=Foggy Glass	Default=one unplugged entry -1P=Two entries, 1 plastic plug, 1 opening -2G=Two entries, plastic gland each -3G=Two entires, with 1 plastic plug, 1 plastic gland	Default=G3/4 Pendant mout only -B1=W/T Painted bracket mount only -B4=W/T Painted and G3/4 Pendant mount	Default=Non Emergency EM1= 1.5H, 30% output EM2= 3H, 15% output

*Also available for stainless steel mount type, details pls contact Crouse-Hinds sales.

Installation and Dimension

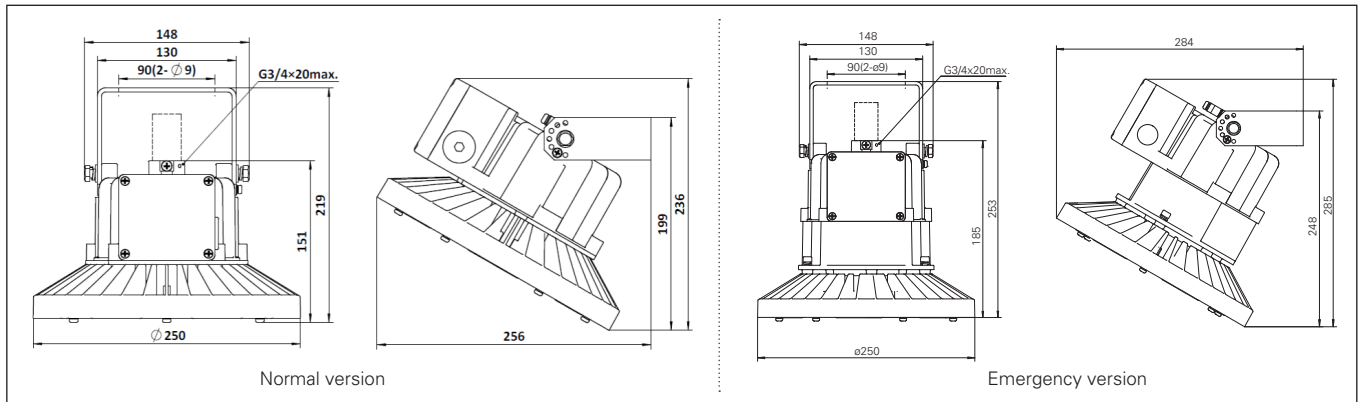

Polar Curve

